

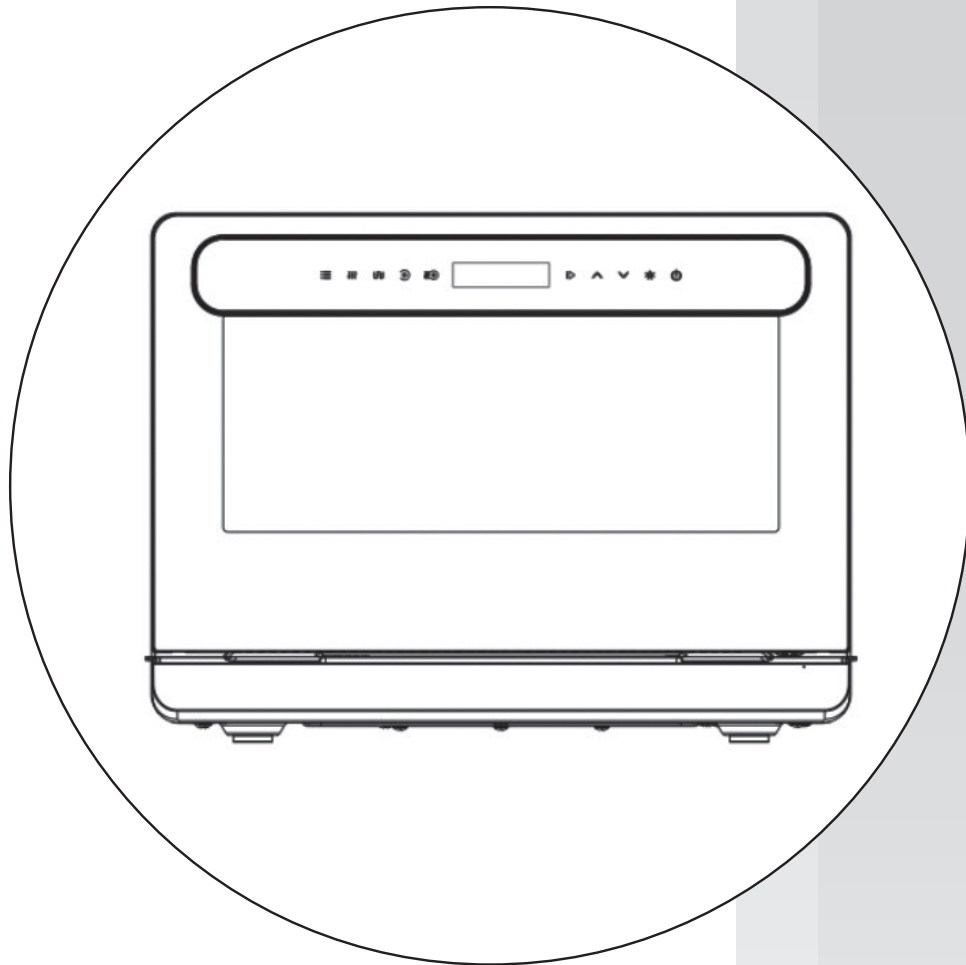

## RSG-TT320/B

蒸氣焗爐 Steam Grill Oven



僅適用於家庭使用  
For household use only

## 使用說明書

## OPERATION MANUAL

- 在使用本產品前，請仔細閱讀本說明書，並妥善保存本說明書以備用戶日後查詢。  
Please read the operation manual carefully before using and well keep it in a safe place for future reference.
- 本說明書中的圖示可能有與實物不同的地方，僅供參考。  
Some figures in this manual may not match with the real object, just for reference only.

---

非常感謝您選購樂信牌座檯式蒸氣焗爐，在使用前請先詳細閱讀本說明書，並保存以備日後參考。

## 目錄

1. 安全注意事項
2. 清潔及保養
3. 產品規格
4. 產品說明
5. 使用說明
6. 故障排除
7. 特別聲明
8. 售後服務

## 1. 安全注意事項

使用本產品時，必須遵守下列安全預防措施，不遵守或忽視這些安全事項會導致火災、觸電或個人受傷。

### 1.1 首次使用及使用前注意事項

1. 取出所有包裝物料。如本產品玻璃門或托盤附有保護膜，使用前須將保護膜撕掉。
2. 檢查本產品有否任何損壞、爐門可否正常關閉，以及爐門內部和內腔有否損壞。如有，應立即聯絡信興電器服務中心有限公司進行檢查或維修。
3. 接通電源前，請先檢查本地電壓是否與產品額定電壓相符。將插頭插入合適的插座上，而插座亦必須接駁地線。
4. 如電源線或插頭出現損壞，或產品曾跌落出現損壞，應立即停止使用本產品，並聯絡信興電器服務中心有限公司檢查或維修。
5. 使用前建議注水至水箱最大刻度處，並且把水箱充分插入爐內，確保固定穩妥，以免運作時無法泵水而導致不能運作。
6. 安裝過程中，檢查電源線有否受潮，或機背有否與邊緣鋒利的物品接觸。另外，高溫可能會損害電源線。
7. 產品於出廠前均會進行多次功能測試，以確保運作正常。部分水氣、水漬或會殘留於水箱或內腔，此乃正常情況，客戶用扭乾的濕布擦拭便可。
8. 按照**章節2.清潔及保養**中提供的說明清潔產品和配件。
9. 於生產過程可能有保護油殘留機體內腔，並可能有異味或輕煙釋出，此乃正常現象，使用數次後問題將會有所改善。使用時保持窗門通風良好。

### 1.2 使用後

1. 關掉本產品及截斷電源，避免因長時間通電導致內部電子組件損毀(老化)，甚至引起火警。
2. 保持清潔，做好防蟲、防塵、防潮的保護，避免蟑螂等昆蟲進入排氣口而造成電路板短路。

### 1.3 重要安全指示

1. 將產品平穩置於乾爽及機頂沒有阻擋的地方使用。另外，為使產品有足夠散熱空間，產品兩側距離牆壁不少於5厘米，而機背距離牆壁亦不少於10厘米。
2. 如烹調過程中需打開爐門，這會使蒸汽和熱量流失，影響烹調效果。
3. 過熱的脂肪和油較容易著火。烤肉期間，嚴禁添加熱油類產品，此舉十分危險！此外，切勿用水或其他液體撲滅正燃燒的脂肪或油(可能發生爆炸)，應用濕布撲滅火焰，並保持室內門窗關閉。
4. 烹調過程中如因需要翻轉食物或其它需要必須打開爐門時，請勿讓兒童或使用者身體部位(特別是臉部)靠近產品，以免被蒸汽燙傷。
5. 使用期間或使用後的短時間內產品仍然十分灼熱。切勿用手或其他物件(如取物夾、隔手套等)觸摸蒸氣爐內腔發熱元件或其他高溫部件。否則有燙傷危險或造成損壞！
6. **注意！**在烹調過程中或在烹調結束時打開爐門，必須小心噴出的蒸氣、蒸氣氣流及高溫水滴，應保持適當的距離以免燙傷！
7. **注意！**確保本產品的電源線沒有貼近爐身，否則電源線的絕緣材料或會熔化，造成短路的風險。
8. 本公司對任何因不正確使用或任何產品之故障、損毀或停頓而引致任何人士或財產的直接或間接損失概不負責。
9. 加熱嬰兒食品時，在餵食前緊記先將食物加以攪拌及測試溫度，以確保熱力分佈均勻，從而避免燙傷或灼傷嬰兒。

10. 為免損壞本產品或引致危險情況，使用時必須注意以下事項：
  - 切勿覆蓋及堵塞通風口。
  - 切勿將易燃物品置於爐內，可能會引起火警。
  - 切勿將本產品視作儲藏食物的地方。
  - 切勿在發燙的食物澆上酒精佐料(如：白蘭地、威士卡、酒精飲料等)，過程中有可能引起爆炸！
11. 當爐門完全打開後，禁止在爐門上放置任何物品。
12. 請勿將蒸氣焗爐的電源線、插頭或其他任何部分浸在水中或液體中，以免造成火災或危險。
13. 時刻保持爐門關閉。確保在爐門完全關上後，才可操作本產品。
14. 避免使用鋒利的器具刮傷門邊密封膠邊或機體，以免造成機身破裂及漏水，導致觸電。
15. 如發現爐門不能緊閉、爐門變形或爐門的組件(如：密封膠邊)出現損壞，為免危險應立即停止使用，並聯絡信興電器服務中心有限公司進行檢查及維修。
16. 切勿在機身與爐門之間放置任何物品，或讓灰塵積存於門縫。
17. 此產品可供年齡在8歲或以上的兒童及體質、感覺或智力有障礙人士或缺乏經驗和相關知識的人士使用，但他們必須接受負責安全人士的監督或指導如何安全地使用產品和理解所涉及的危險。
18. 切勿讓兒童清潔及保養產品，除非兒童是年齡在8歲以上及監督的情況下。監督兒童不可將產品當作玩具。將產品及其電源線放於八歲以下兒童不能接觸的地方。

#### 1.4 操作注意事項

1. 從內腔取出食物和器皿時，應使用合適的器皿或戴上隔熱手套，以免高溫燙傷。
2. **警告！**除合資格的維修人員外，禁止其他人檢查及維修本產品，以免發生危險。
3. 如電源線損壞，為避免危險，必須聯絡信興電器服務中心有限公司進行維修及更換。
4. 電源連接的插座和電路必須可靠接地，並須由具備專業資格人員安裝，保證產品安裝後仍能夠完全有效地斷開本機的電源連接。
5. 切勿將易燃物置於機頂或機內，以免導致起火。在配件沒有完全安裝妥當的情況下，切勿使用本產品。
6. 切勿使用外置計時器或遙控系統來操作本產品。
7. 運作時或使用後，外殼、機內及可觸及部件會變得灼熱，切勿接觸以免燙傷，特別是小孩必須與本產品保持適當距離。待產品冷卻30分鐘後再進行清潔，以免被餘熱灼傷。
8. 切勿將本產品用於烹調食物以外的其他用途。(如本產品用於其他用途有可能發生故障。)
9. 切勿用水淋洗機身、電源線或插頭，以免影響產品的安全性能及防止造成觸電的危險。
10. 小心使用電源線，不可在電源線上放重物或夾住電源線；不可改裝電源線；切勿用力拉扯或扭曲電線；在拔出或插入插頭時，要用手握穩插頭本身。切勿將電源線懸掛在桌子、櫥櫃的邊緣或令其接觸發熱的表面。
11. 長期不使用時，應將插頭從插座內拔出，以免因絕緣老化而發生漏電及觸電危險。切勿使用濕手接觸、插入或拔出插頭，以免觸電。
12. 烹調前，先注水至水箱注水口位置，但切勿令水滿溢。確保將水箱充分插入機底水箱槽，以免工作時未能泵水而導致不能運作。
13. 烹調過程中，盡量避免打開爐門令蒸氣流失，影響烹調效果。如有需要打開爐門(如翻轉食物)，身體部位(特別是臉部)盡量不要靠近爐門，

14. 移動、檢查或清潔本產品前，應先拔掉電源線插頭，待本產品冷卻後再進行。
15. 本產品是為家庭或類似環境烹調食物而設(如：商店內部、辦事處以及其他工作環境的員工廚房區域或類型的環境)。切勿在室外使用，或用作說明書建議以外的其他用途。如使用不當，或作為(半)商業用途，維修保養將無效，本公司將不會承擔任何損壞的維修責任及賠償。
16. 切勿讓嬰兒靠近。若有孩童在旁，須加倍小心使用及看管小孩，以確保他們不會把此產品當作玩具。切勿讓小孩單獨使用，亦切勿將本產品及其電源線放於小孩能觸及的地方。
17. 如果電源線爐門或爐門密封圈損壞，需停止使用並預約信興電器服務中心進行維修後方可再次使用。
18. 經常檢查本產品的電源線及爐門等是否有破損，或曾否跌落；如有懷疑，為避免危險應停止使用，並聯絡信興電器服務中心有限公司作檢查及維修。
19. 切勿擅自改裝產品或使用非生產商提供的配件或零件進行修理，否則會造成危險及維修保養無效。
20. 遵從安全守則及避免釀成意外，如需維修電器，立即聯絡信興電器服務中心有限公司(地址印於本說明書的背頁或致電2406 5666查詢)，並確保在檢查或維修時出示產品保修登記及收據。

## 2. 清潔及保養

建議用戶參照以下各項，定期檢查及保養產品，可避免出現故障。

1. 烹飪完成後，產品內腔尚有餘溫，待產品完全冷卻才進行清潔。
2. 為使本產品能正常運行，爐門玻璃應盡量保持乾淨。切勿使用磨蝕性的清潔劑或尖銳的金屬刮刀清潔爐門玻璃，因為此等物品會劃傷產品表面，甚至造成破裂。  
\* 切勿於產品運作時用冰冷的濕布擦拭玻璃，以防玻璃因冷縮熱脹造成損毀。
3. 清潔本產品前，必須確保本產品已關閉，並從插座上拔去電源插頭。
4. 經常保持內腔清潔。當食物或任何液體濺到內腔時，可用濕布抹拭(\*圖1)。如內腔十分骯髒，可選擇使用中性的清潔劑。切勿使用粗糙潔具(如鋼絲刷或百潔布)或磨損性的清潔劑進行清潔。另外，可用溫水清洗附件(\*圖2)，避免直接用冷水沖洗。

提示！用戶可按住上發熱管的固定扣，稍微往後壓撥片使上發熱管可向下擺，即可對內腔頂部進行清潔(\*圖3)。

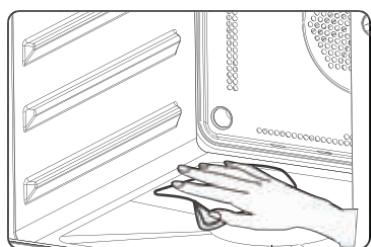

(圖1)

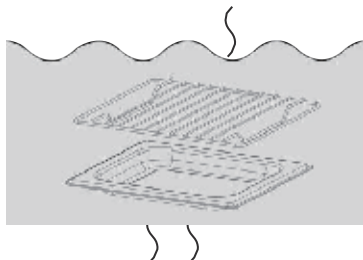

(圖2)

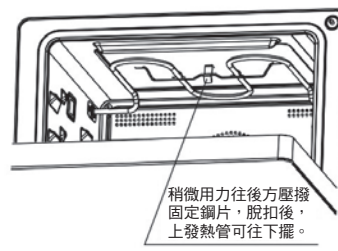

(圖3)

5. 建議使用清水或蒸餾水進行烹調，若長期使用自來水，腔體內壁或會形成水垢。切勿使用礦泉水，否則會加快水垢形成。
6. 建議每週清洗水箱一次，可利用柔軟的細布輕輕擦拭。完成後將水箱放回原處。
7. 經常清潔爐門的密封膠邊，可用濕布擦淨。

8. 如控制面板被弄濕，可用濕布擦乾，切勿使用粗糙、磨損性的清潔劑抹拭控制面板。清潔時，請先將電源切斷，以免導致錯誤操作。
9. 如長期不使用本產品，應拔掉電源插頭，清潔內腔後放在通風、乾燥、沒有腐蝕性氣體的環境中。
10. 如產品發生故障，必須由信興電器服務中心有限公司進行檢查及維修。
11. 使用軟質物料(如布類)清潔食物盤、集油盤等器皿。切勿使用硬質物料(如金屬類物料)，以免刮傷器皿，破壞保護層。
12. 切勿使用有毒或含腐蝕性清潔劑進行清潔。
13. 清洗配件後，必須完全擦乾及安裝妥當後，才接上電源。
14. 如需存放，必須待本產品完全冷卻及清洗後才能進行。儲存時，請放入紙箱，然後放置於乾爽的環境中。
15. 切勿將電源線纏繞在本產品或壓住電源線，避免造成電源線磨損和破裂。

**注意！** 切勿淋水、直接用水或浸在水中清洗本產品。

**注意！** 切勿使用烈性清潔劑(如：天拿水)、汽油、研磨粉和金屬刷來清洗本產品。長時間使用本產品後，內腔或會囤積異味，用戶可於內腔放置5-6片檸檬，並使用蒸氣功能[SSS]進行清洗。設定100°C烹調溫度及運作15-20分鐘，可將異味清除。

### 3. 產品規格

型號	RSG-TT320/B
顏色	黑色
額定電壓	220-240V ~ 50-60Hz
額定功率	2,000瓦
容量	32公升
產品尺寸(闊×深×高)毫米	約472.6 × 517 × 365.7
內腔尺寸(闊×深×高)毫米	約387 × 342 × 244
水箱容量(升)	約0.9
淨重(公斤)	約16.7

\* 內腔容量是根據內腔尺寸之最大闊度、深度和高度而得出，實際存放食品的容量稍少於以上數值。



## 4. 產品說明

### 4.1 產品結構

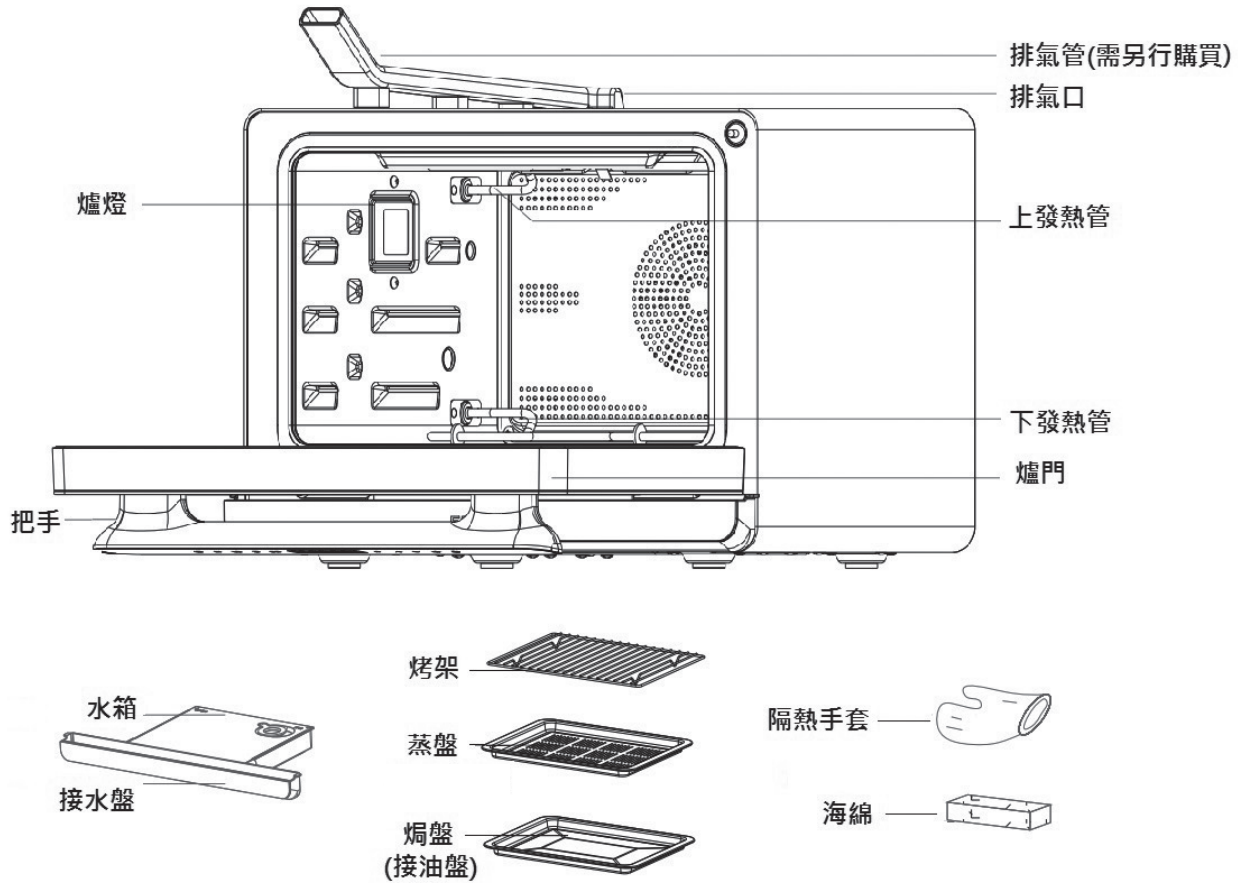

註：上述圖片僅供參考，尺寸比例或有差異，以實物為準。

\* 如需額外配置排氣管，可聯絡信興服務中心有限公司熱線：2406 5666查詢。

## 4.2 顯示面板及控制面板說明



### 控制面板說明

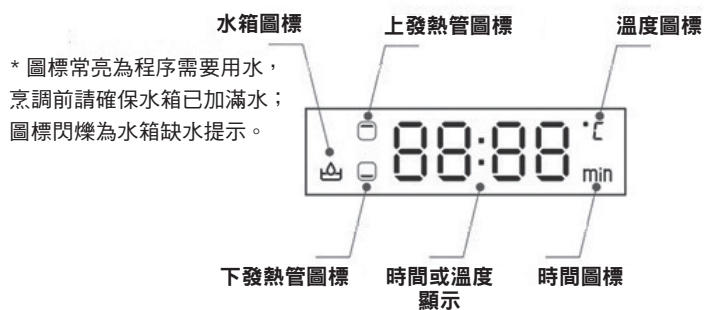



### 顯示面板說明



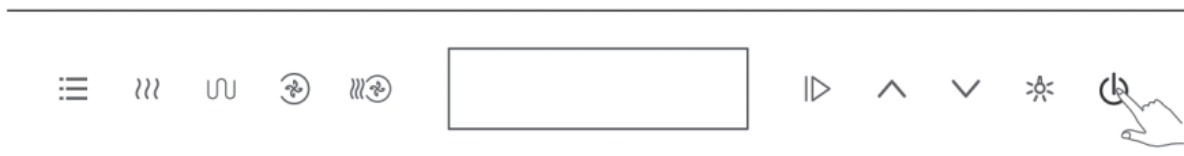

## 5. 使用說明

### 5.1 備用狀態



接通電源，蜂鳴器發出「嗶」一聲提示聲，電源鍵[]亮起，按電源鍵[]1次，所有功能鍵及顯示屏的時間圖示「88:88」亮起，產品進入備用狀態，用戶可開始進行設置。

約1分鐘內未有任何設置，所有功能鍵及顯示屏指示燈將熄滅，電源鍵[]亮起，產品返回備用狀態；可按電源鍵[]1次再次進行設置。



## 5.2 操作指引

1. 根據烹調的食材選擇合適的烤架、蒸盤或焗盤(接油盤)；

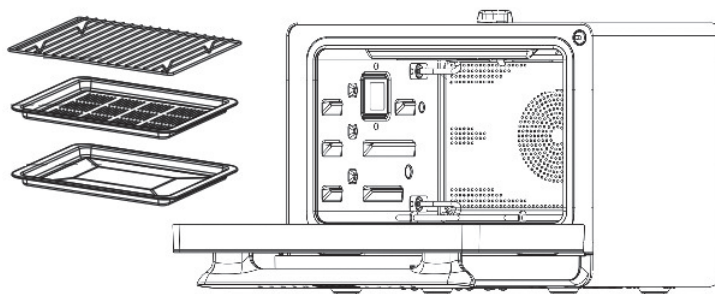

2. 如使用蒸氣功能(包括蒸氣及蒸烤)，請為水箱注滿蒸餾水，以免機器因缺水而停止運作；  
**注意！** 使用蒸氣功能烹調時，如水箱水量不足，產品將暫停運作，水箱圖標「☁」及時間顯示會於顯示屏閃爍及持續發出「嗶」提示聲；為水箱注滿水並放回機體後，按確定/暫停鍵「|▶」繼續運作。  
**注意！** 注水過多會令水箱滿溢，引致漏水情況。
3. 關上蒸氣焗爐門，確定接上電源，按電源鍵「⏻」，產品進入備用狀態。
4. 如在烹調時，需關閉本產品，按電源鍵「⏻」1次，蜂鳴器會發出「嗶」一聲，烹調運作將停止，所有功能鍵及顯示屏指示燈將熄滅，電源鍵「⏻」亮起，產品返回通電狀態。

## 5.3 功能操作說明

功能模式：蒸氣[☁] / 熱風對流[☼] / 蒸烤[☁☼]

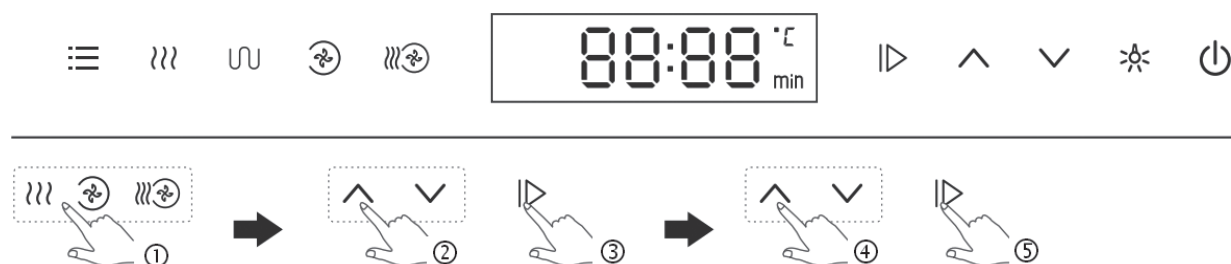

操作步驟：

1. 在備用狀態下，按下蒸氣[☁]、熱風對流[☼]或蒸烤[☁☼]烹調功能；
2. 按[^]或[v]調整所需烹調溫度(功能的溫度調節範圍可參考)；
3. 按[▶]確定；
4. 按[^]或[v]調整所需烹調時間(功能的時間調節範圍可參考烹調功能運作時間表)；
5. 按[▶]開始運作。

### 功能模式：燒烤 [U] (上下發熱管獨立控溫)

產品設有獨立使用上/下發熱管。設置溫度時，按[^]或[∨]直到顯示屏出現「OFF」，即可關閉相應的發熱管。

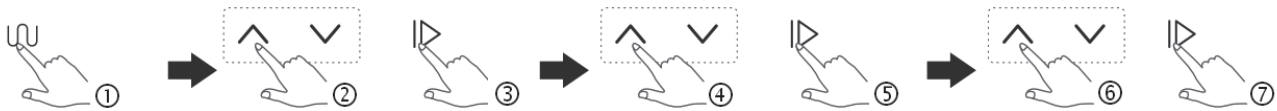
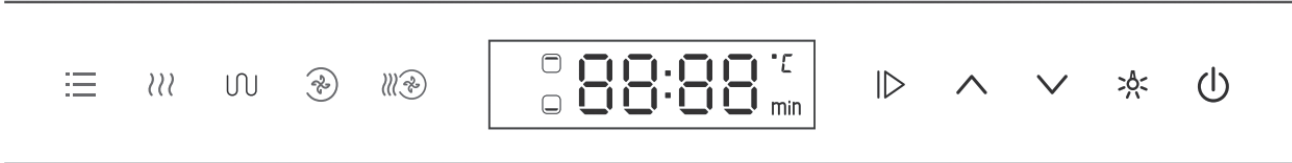

操作步驟：

1. 在備用狀態下，按下燒烤[U]烹調功能；
2. 按[^]或[∨]調整上發熱管(☐)所需烹調溫度(功能的溫度調節範圍可參考烹調功能運作時間表)；
3. 按[▶]確定；
4. 按[^]或[∨]調整下發熱管(☐)所需烹調溫度(功能的溫度調節範圍可參考烹調功能運作時間表)；
5. 按[▶]確定；
6. 按[^]或[∨]調整所需烹調時間(功能的时间調節範圍可參考烹調功能運作時間表)；
7. 按[▶]開始運作。

### 烹調功能運作時間表

功能	圖示	預設溫度	溫度調節範圍	預設時間	時間調節範圍
蒸氣	☁	100°C	30-100°C	00:20	00:01-03:00
燒烤	U	180°C	100-230°C	00:25	00:01-03:00
熱風對流	☼	120°C	50-230°C	00:30	00:01-03:00
蒸烤	☁☼	160°C	120-200°C	00:30	00:01-03:00

**注意！**為確保爐內溫度足夠，運作前請額外預留5-10分鐘預熱(或可參考自選食譜內燒烤預熱或蒸氣預熱功能)。

**注意！**每次蒸煮完畢後，建議即時清空接水盤以免溢瀉。

**注意！**請勿於烹調運作過程中長時間暫停運作或打開爐門，令爐內溫度驟降或低於預熱溫度值，會影響食物品質及加長烹調時間。

**注意！**請確保爐腔內的食物或容器能承受該溫度設置。切勿使用任保鮮紙或塑膠容器，以免發生意外。

**警告！**使用本產品時不要使用保鮮紙、塑膠或任何紙製容器，以免發生意外。

### 重置烹調時間方法

如烹調過程中需要重新設置烹調時間，用戶可按確定/暫停鍵「▶」暫停，並按上調鍵[^]或下調鍵[∨]對該功能的烹調時間進行調整，完成後，可按確定/暫停鍵「▶」恢復運作。

\* 烹調過程結束後，顯示屏會顯示"End"並發出10聲「嗶」提示聲。

## 5.4 自選食譜烹調操作(溫度及時間不可自行調校)

用戶可按自選食譜鍵[≡]選擇內置自選食譜(Auto Menu)，詳細可參考下表。

\* 代碼分類為A、b、F、S、H或P，用戶選擇食譜過程中，需先選擇英文代碼(A、b、F、S、H或P)，再選擇數字代碼(01-24)，操作步驟請參考下方說明。

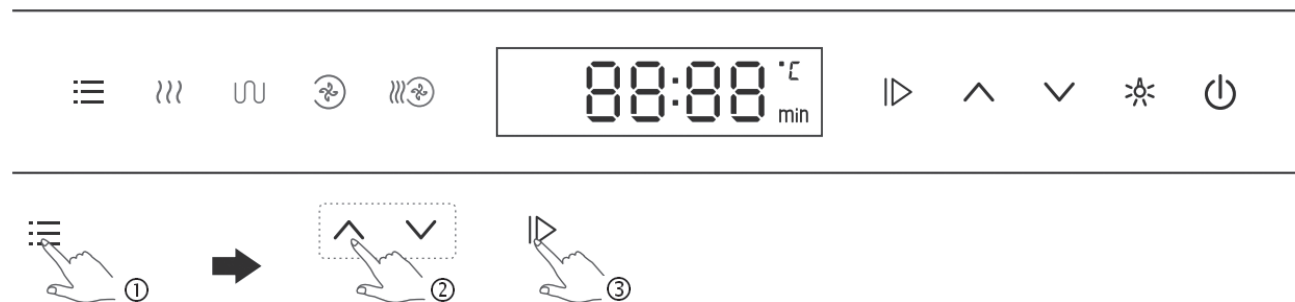

操作步驟：

1. 於備用狀態下，按自選食譜鍵[≡]選擇內置的自選食譜，時間/溫度顯示轉為「A01」，用戶可再按自選食譜鍵[≡]選擇英文代碼A、b、F、S或H(可參考自選食譜清單)；
2. 按[▲]或[▼]調整所需食譜代碼(可參考自選食譜清單)；
3. 按[▶]開始運作。

### 自選食譜清單

顯示代碼	自選菜單	功能	時間(小時:分鐘)	溫度
A01	清蒸黃花魚	蒸氣	0:14	100°C
A02	蒸蟹	蒸氣	0:18	100°C
A03	百合蒸南瓜	蒸氣	0:25	100°C
A04	蒸水蛋	蒸氣	0:18	100°C
A05	蒜蓉粉絲蒸扇貝	蒸氣	0:15	100°C
A06	清蒸鯽魚	蒸氣	0:17	100°C
A07	清蒸鱸魚	蒸氣	0:15	100°C
A08	蒸排骨	蒸烤	0:28	120°C
A09	清蒸娃娃菜	蒸氣	0:10	100°C
A10	蒸米飯	蒸氣	0:38	100°C
A11	蒸紅薯	蒸氣	0:26	100°C
A12	清蒸玉米	蒸氣	0:33	100°C
A13	清蒸西蘭花	蒸氣	0:25	100°C
A14	清蒸蘆筍	蒸氣	0:17	100°C
A15	清蒸胡蘿蔔	蒸氣	0:20	100°C
A16	清蒸菜心	蒸氣	0:18	100°C
A17	翻熱麵點(蒸餃)	蒸氣	0:17	100°C
A18	香菇蒸滑雞	蒸氣	0:27	100°C
A19	清蒸花生	蒸氣	0:22	100°C

顯示代碼	自選菜單	功能	時間(小時:分鐘)	溫度
A20	清蒸蓮藕	蒸氣	0:22	100°C
A21	清蒸荷蘭豆	蒸氣	0:20	100°C
A22	清蒸毛豆	蒸氣	0:22	100°C
A23	清蒸薯仔	蒸氣	0:28	100°C
A24	清蒸小芋頭	蒸氣	0:18	100°C

顯示代碼	自選菜單	功能	時間(小時:分鐘)	溫度
b01	檸檬龍利魚	熱風對流	0:25	200°C
b02	蒜蓉豉汁蒸鮑魚	蒸烤	0:21	180°C
b03	錫紙烤鱸魚	熱風對流	0:45	200°C
b04	烤牛扒	蒸烤	0:19	190°C
b05	烤粟米	燒烤	0:26	200°C
b06	蜂蜜醬香排骨	蒸烤	0:33	200°C
F01	川貝燉雪梨	蒸氣	1:02	100°C
F02	橘子蘋果水	蒸氣	0:50	100°C
F03	牛奶燉木瓜	蒸氣	0:26	100°C
F04	冰糖雪梨飲	蒸氣	0:58	100°C
F05	紅棗馬蹄銀耳羹	蒸烤	0:43	110°C
F06	蓮子百合燉銀耳	蒸烤	1:18	110°C
F07	紫薯銀耳羹	蒸烤	0:40	110°C
F08	雪梨燉銀耳	蒸氣	0:33	100°C
F09	紅棗銀耳燉雪梨	蒸氣	1:00	100°C
F10	木瓜燉雪梨	蒸氣	0:58	100°C

顯示代碼	自選菜單	功能	時間(小時:分鐘)	溫度
S01	魚類保溫	蒸氣	0:30	35°C
S02	肉類保溫	熱風對流	0:30	50°C
S03	蔬菜類保溫	蒸氣	0:30	40°C
S04	麵食類保溫	蒸氣	0:45	35°C
S05	湯類保溫	蒸氣	1:00	50°C

顯示代碼	自選菜單	功能	時間(小時:分鐘)	溫度
H01	麵包	一次發酵	0:25	35°C
		二次發酵	1:40	40°C
		熱風對流	0:15	50°C
		燒烤	0:15	180°C
H02	自製優酪乳	發酵	9:00	40°C
H03	翻熱麵包	蒸烤	0:08	180°C
H04	蘋果片	熱風對流	1:30	110°C
H05	檸檬片	熱風對流	1:45	110°C
H06	溫青酒	蒸氣	0:08	80°C
H07	溫牛奶	燒烤	0:05	180°C
H08	熱巧克力	燒烤	0:14	180°C

## 5.5 燒烤預熱／蒸氣預熱溫度設定

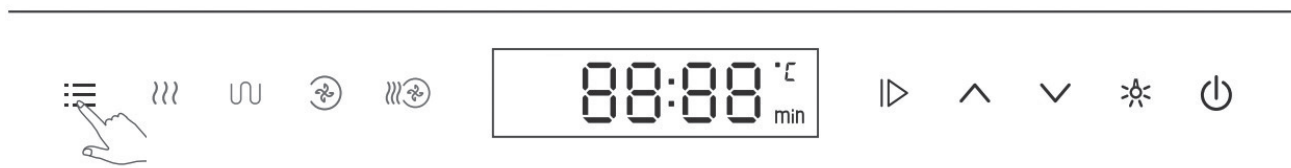

操作步驟：

1. 於備用狀態下，按自選食譜鍵[≡]選擇內置的自選食譜，時間／溫度顯示轉為「A01」，再按自選食譜鍵[≡]調整至英文代碼(P)(食譜代碼及細節可參考下表)；
2. 按[^]或[∨]調整所需食譜代碼(可參考自選食譜清單)；
3. 按[▶]確定；
4. 按[^]或[∨]調整所需預熱溫度(可參考自選食譜清單)；
5. 按[▶]開始運作。

### 自選食譜清單

顯示代碼	自選菜單	功能	時間(小時：分鐘)	溫度
P01	燒烤預熱	不適用	不可調校	預設180°C， 可調校100-230°C
P02	蒸氣預熱	不適用	不可調校	預設100°C 可調校50-100°C

## 5.6 解凍／發酵功能設定

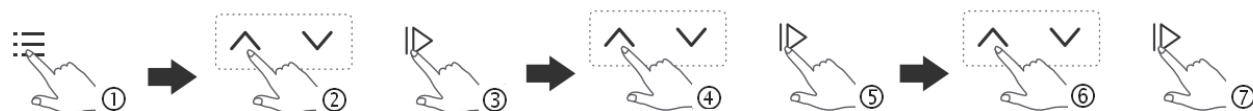

操作步驟：

1. 於備用狀態下，按自選食譜鍵[≡]選擇內置的自選食譜，時間／溫度顯示屏轉為「A01」，再按自選食譜鍵[≡]調整至英文代碼(P)；
2. 按[^]或[∨]調整所需食譜代碼(可參考自選食譜清單)；
3. 按[▶]確定；
4. 按[^]或[∨]調整所需溫度(可參考自選食譜清單)；
5. 按[▶]確定；
6. 按[^]或[∨]調整所需時間(可參考自選食譜清單)；
7. 按[▶]開始運作。

### 自選食譜清單

顯示代碼	自選菜單	功能	時間(小時:分鐘)	溫度
P03	解凍	不適用	預設0:20 可調校0:01-3:00	預設50°C 可調校40-60°C
P04	發酵	不適用	預設1:00 可調校0:01-12:00	預設40°C 可調校30-40°C

### 5.7 附設功能(溫度及時間不可自行調校)

除各個烹調模式外，自選食譜鍵[≡]中亦有以下附設功能供用戶選擇(可參考自選食譜清單)；

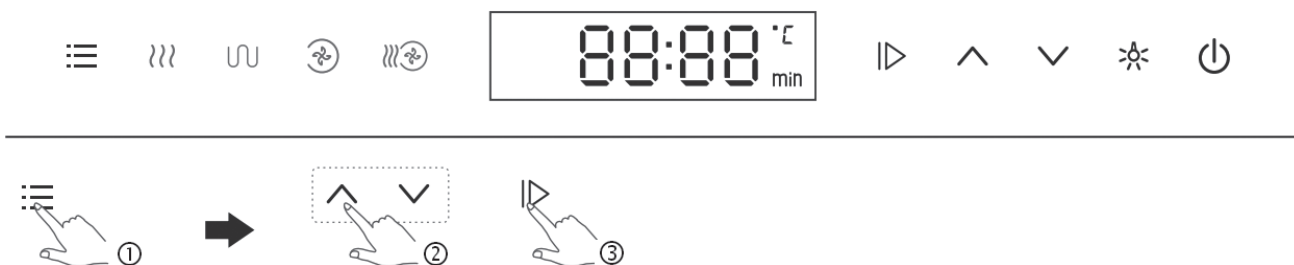

操作步驟：

1. 於備用狀態下，按自選食譜鍵[≡]選擇內置的自選食譜，時間/溫度顯示屏轉為「A01」，再按自選食譜鍵[≡]調整至英文代碼(P)(可參考自選食譜清單)；
2. 按[^]或[v]調整所需設定代碼(可參考自選食譜清單)；
3. 按[▶]開始運作。

### 自選食譜清單

顯示代碼	自選菜單	功能	時間(小時:分鐘)	溫度
P05	暖毛巾	蒸氣	0:06	50°C
P06	暖杯	蒸氣	0:05	50°C
P07	蒸氣系統管路清潔	蒸氣	0:06	90°C
P08	餐具除菌	蒸烤	0:20	110°C
P09	除垢	蒸氣	0:25	100°C
P10	爐腔烘乾	熱風對流	0:13	200°C

### 5.8 除垢功能設定

首先，將20毫升除垢劑及200毫升清水注入水箱，然後於自選食譜中選取代碼(P09)除垢功能，再按「▶」開始運作。

**注意！**完成除垢功能後，抹乾爐腔，移除及清空水箱後再放回原處。

### 5.9 實時溫度

於烹調過程中用戶可長按自選食譜鍵[☰] 3秒查詢實時溫度。

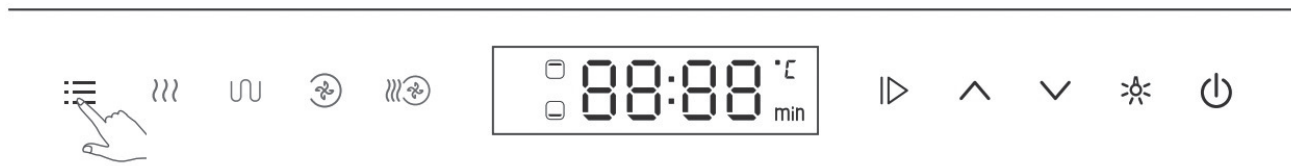

### 烹調小貼士

1. 以上建議烹調時間只供參考，食物可能因為溫度、食物種類、份量及型狀等不同而各有差異，用戶需根據個人經驗及實際情況進行調整。
2. 烹調冷凍食物需時較長，烹調時間應根據實際烹調情況作出調整。
3. 時刻留意烘烤中的食物，避免烤焦，影響烹調效果。
4. 烘烤時，爐門玻璃或會出現水蒸氣，此由食物當中的水分蒸發所造成，屬正常現象，並不影響產品運作。
5. 切勿在烘烤過程中或玻璃尚有餘熱時用冰冷的濕布擦拭，否則玻璃有可能因此而破裂。
6. 為防止爐溫過高，當烹調溫度達到預設溫度時，發熱管會暫停加熱，待爐溫下降後便會恢復運作。
7. 切勿在加熱中途將食物拿出，否則會出現加熱不足的情況。
8. 建議於預熱模式完成後才放入食物，以免烹調時間出現偏差，影響烹調效果。

### 5.10 童鎖功能

產品設有童鎖功能用來鎖住按鍵，以防止兒童在沒有成人指導的情況下使用本產品。



- i. **啟動童鎖**：於備用狀態或運作狀態下，長按爐燈鍵[☀] 3秒，爐燈鍵[☀]會閃爍，表示進入童鎖狀態。
- ii. **解除童鎖**：於備用狀態或運作狀態下，長按爐燈[☀] 3秒，爐燈鍵[☀]會停止閃爍，即可解除童鎖狀態。

### 5.11 爐燈運作說明

產品內腔設有爐燈，用於照明；爐燈會於以下情況下亮起：

- i. 產品備用狀態下，任何情況打開爐門，亮起約1分鐘後熄滅；
- ii. 烹調功能開始運作後，亮起約3分鐘後熄滅；
- iii. 烹調功能完結後打開爐門，亮起約2分鐘後熄滅。
- iv. 運作過程中按爐燈鍵「☀」一下亮起，再按「☀」一下熄滅；



### 運作小貼士：

- 烹調完成後，排氣風扇會延時運作2分鐘，將爐腔內的熱量排清，這是正常現象；
- 在烹調過程中，用戶將爐門打開，產品將自行暫停運作；
- 當用戶將爐門關上，則自動啟動繼續烹調。

## 6. 故障排除

故障代碼/現象	可能原因	排除辦法
Er3	腔體下管傳感器開路	聯絡信興電器服務中心有限公司進行檢查及維修
Er4	腔體下管傳感器短路	
Er5	蒸發盤傳感器開路	
Er6	蒸發盤傳感器短路	
Er7	腔體上管傳感器開路	
Er8	腔體上管傳感器短路	
顯示螢幕不亮	1. 蒸氣焗爐沒有接通電源 2. 電源線不能正常運作	1. 將蒸氣焗爐接駁電源 2. 聯絡信興電器服務中心有限公司進行檢查及維修
顯示螢幕顯示異常	1. 顯示螢幕損壞 2. 電路板電子元件損壞	聯絡信興電器服務中心有限公司進行檢查及維修
烹調期間水或水蒸氣洩露出爐門	1. 爐門不能完全關上 2. 爐門的密封層破壞	1. 重新將爐門關緊 2. 聯絡信興電器服務中心有限公司進行檢查及維修
爐燈不亮	1. 爐燈損壞 2. 主電路板損壞	聯絡信興電器服務中心有限公司進行檢查及維修
風扇摩打不運作	1. 摩打不損壞 2. 主電路板損壞	
按鍵失靈	1. 控制面板裝配不良或損壞 2. 電路板電子元件損壞	
不出蒸氣	1. 水管折彎、堵塞或損壞 2. 水泵損壞 3. 注水系統密封不良	

### 注意：

- 1、 如果蒸氣焗爐不能正常運作，應檢查以下：
  - 電源插頭是否插好；
  - 爐門是否關好；
  - 水箱是否安裝穩妥；
  - 主電流斷路器是否跳掣或燒斷保險絲；
  - 兒童安全鎖是否已啟動。
- 2、 爐腔內未放食物而蒸氣焗爐被意外啟動：請立即按電源鍵[⏻]，使其停止運作。

## 7. 特別聲明

1. 本資料上所有內容經過核對，如有任何印刷及內容上的誤解，本公司將保留解釋權。
2. 本產品若有技術改進，會編進新版說明書中，恕不另行通知；產品外觀、顏色如有改動，則以製造商資料為準。
3. 如本資料之中英文版本有差異時，應以中文版為準。
4. 使用說明書的電子副本可以通過電子郵件發送致客戶，如有需要，可致電信興電工工程有限公司：28612767。

## 8. 售後服務

1. 由購買收據日期起之一年保修期內，經信興電器服務中心有限公司之服務人員證實產品故障屬正常使用下發生者，本公司將提供免費維修或更換零件服務。經更換之任何損壞零件，將歸屬本公司所有。保修範圍不包括修理或更換零件及消耗品如電源線、水箱、爐門、機殼、焗盤、烤架、蒸盤、接水盤及隔熱手套等。如不當使用，或作為(半)商業用途，或未依照說明書使用，保修服務將無效，本公司將不會承擔任何損壞的維修責任及賠償。
2. 用戶必須於維修時出示購買／換購收據及蓋有銷售點／換購中心印章的保修登記卡。如有任何疑問，請致電信興電器服務中心有限公司熱線：24065666查詢。

---

Thank you for choosing Rasonic Freestanding Steam Grill Oven. Read the operation manual carefully before using and keep it for your future reference.

## **Table of Contents**

1. Important Safeguards
2. Cleaning and Maintenance
3. Product Specification
4. Product Description
5. Operation Instruction
6. Troubleshooting
7. Special Avowal
8. After Sales Service

## 1. Important Safeguards

Observe these following safety precautions when using the appliance. Failure or negligence in observing these safety precautions could cause fire, electric shock or personal injury.

### 1.1 Note for first use and before use

1. Remove all packaging materials. The appliance may have a protective film covering the oven door or food trays, remove the protective film carefully before use.
2. Check if there is any damage on the appliance. Ensure that the oven door can be closed properly, cavity and interior door opening with no damage. If there is any damage, contact Shun Hing Electric Service Center Ltd. for checking and repairing.
3. Before connecting to the electricity, make sure the rated voltage on the appliance corresponds to the local voltage. Make sure the appliance is connected to power socket with grounding.
4. If the power cord or plug is damaged, or if the appliance is damaged or dropped, do not use and contact Shun Hing Electric Service Center Limited to check and repair immediately.
5. Before cooking it is recommended to fill the water tank to the maximum level indicated, and insert the tank completely into the appliance to ensure that it is fixed in place, so as to prevent failure to pump water during operation.
6. During installation, check the power cord to ensure it is dry and no sharp edges in contact with the back of the appliance. In addition, high temperature may damage the power cord.
7. To ensure proper operation, the appliance will be tested several times during production. Water vapor and stains may remain in the water tank or the cavity. This is a normal phenomenon, wipe with a dry damp cloth.
8. Follow the instructions shown in **Chapter 2. Cleaning and Maintenance** to clean the appliance and accessories.
9. During production process, there may be protective oil residue in the oven cavity, and there may be odor or light smoke release. This is a normal phenomenon, and the problem will be improved after several times of use. Keep the window and door well ventilated during operation.

### 1.2 After usage

1. Turn off the appliance and power supply to avoid damage to the internal electronic components, which may cause a fire.
2. Keep the appliance clean by pests control, dust and moisture protection, which prevents cockroaches and other insects from entering the steam outlet vent, causing short circuit.

---

### 1.3 Important safety instructions

1. The appliance should be placed on a dry steady location, with oven top unblocked, and at least 5 cm away from both sides of the wall for ventilation. The oven rear should be kept 10 cm away from the back wall.
2. Opening the oven door during operation will cause steam and heat loss and hence affect the cooking result.
3. Overheated fat or oil can easily catch fire. When grilling meat, cooking oil during operation is very dangerous and should not be done. To extinguish burning oil or fire, never use water or any liquid (it may explode). Put out the flames with a damp cloth and keep doors and windows closed.
4. When the oven door must be opened due to the need of turning over food or other needs during cooking, ensure children or users' body parts (especially the face) is not near the appliance to avoid steam burn or scalding.
5. Accessible parts may become hot during use or a moment after use. Do not touch the heating element or any hot parts with your hands or tools (e.g. holding rack and heat insulating glove), as it could be dangerous, or cause product damage.
6. **ATTENTION!** When open the oven door at the end or during operation, be careful of the steam discharged from outlet vent and hot water droplets. Keep an appropriate distance to avoid burns!
7. **CAUTION!** Make sure the power cord is not in contact with the oven enclosure. Otherwise, insulating material of the power cord may melt resulting in a risk of short circuit!
8. Our company is not liable for any direct or indirect loss or damage to any person or property, howsoever, caused arising from improper use or any stoppage, breakdown or failure of the product.
9. After heating baby food, remember to stir and check the temperature before serving. Ensure that heat is evenly distributed and the risk of scald or burns can be avoided.
10. To avoid damaging the appliance or dangerous situations, follow the instructions below:
  - Do not cover or block the outlet vent.
  - Do not place flammable items in the cavity because it may cause fire.
  - Do not store food in the appliance.
  - Do not pour alcoholic beverages (such as brandy, whiskey, alcoholic beverages, etc.) on hot food. There is danger of explosion!
11. Do not place anything on the door when it is open.
12. Do not immerse the power cord, plug or any other part of the appliance into water or any other liquid as it may result in fire or danger.
13. Always ensure that the oven door is closed firmly. The appliance will only function when the door closed accordingly.

14. Avoid scratching the door sealing edge or the appliance with sharp items such to prevent the appliance from rupturing or leakage of water, resulting in electric shock. If the door sealing is damaged, replace a new one before use.
15. If the oven door could not be closed properly, deformation or damage of door components (e.g. the rubber packing of oven door), to avoid danger, stop using and contact Shun Hing Electric Service Center Limited to check and repair.
16. Do not place any objects between the appliance and the oven door, or allow dust to accumulate on the door gap.
17. The appliance can be used by children aged from 8 years and above and persons with reduced physical, sensory or mental capabilities, or lack of experience and knowledge, unless they have been give supervision of instruction concerning use of the appliance in a safe way and understand the hazards involved.
18. Cleaning and user maintenance shall not be made by children unless they are older than 8 and supervised. Children being supervised not to play with the appliance. Keep the appliance and its power cord out of reach of children less than 8 years.

#### 1.4 Operating precautions

1. When taking out food and container from the cavity, use safety utensils such as tray holding rack or wear heat insulating gloves to avoid scalding.
2. **WARNING!** Other than qualified service personnel, no experience personnel to perform maintenance service are forbidden because it may cause hazard.
3. If the power cord is damaged, contact Shun Hing Electric Service Center Limited for repair and replacement.
4. Power socket and circuit connection must be grounded and properly installed by professional personnel. Make sure the appliance can be completely disconnected to the power electricity easily.
5. Do not put flammable items inside or on top of the appliance to avoid causing fire. Do not use the appliance when the accessories are not properly installed.
6. Do not use an external timer or remote-control system to operate the appliance.
7. The appliance will become very hot when in use or after using. Do not touch the heating parts, and keep children away from the appliance. Wait for 30 minutes to allow the appliance to cool down before cleaning to avoid burn by residue heat.
8. Do not use the appliance for purposes other than cooking food. (If this product is used for other purposes, there may be a malfunction.)
9. The appliance, power cord and plug should not be in touch with liquid, as it will affect its safety performance and causes electric shock.

- 
10. Do not place weighted objects on the power cord; Never modify, twist or pull the power cord; When unplugging or inserting the plug, make sure to grasp the plug with force; Do not hang the power cord on the table, the edge of the cabinet or make in touch of heated surface.
  11. When not in use, unplug the power to prevent electric shock caused by insulation aging. Never use wet hands to touch, insert or pull the plug out of the socket to prevent electric shock.
  12. It is recommended to fill the water tank to almost full before cooking, and insert the tank completely into the appliance. Make sure that the water tank is fixed in place, and prevent water cannot be pumped during operation.
  13. During operation, do not open the oven door to ensure no steam loss and affect the cooking result. If turn over the food is needed, make sure body parts (especially the face) is not near the oven door, to avoid steam burn or scalding.
  14. Before moving, checking or cleaning the appliance, unplug and proceed after the appliance has been completely cooled down.
  15. The appliance is intended for use in household and similar applications (such as staff kitchen shops, offices and other working and residential type environments), do not use it in outdoor areas or other purposes. If it is used improperly or for (semi) commercial use, the warranty will be invalid and Shun Hing Electric Service Center Limited will not be liable for any damage to the maintenance and compensation.
  16. Keep infants away from the appliance. Use the appliance with care and take good care of your children, make sure they do not play with the appliance. Do not let children use it alone, and place it and its power cord away from children's reach.
  17. If the power cord, door or door rubber seal is damaged, stop using the appliance and make an appointment to have it repaired by Shun Hing Electric Service Center before using it again.
  18. Always check whether the power cord, plug and oven door are working properly. If the steam oven is damaged or dropped, do not use immediately to avoid hazard, and contact Shun Hing Electric Service Center Limited for maintenance and checkup.
  19. Do not replace with any parts or accessories which were produced without authorization. Otherwise, the maintenance guarantee become invalid.
  20. Follow the safety regulations to prevent accidents from happening. Contact Shun Hing Electric Service Center Limited when repair is needed (address is printed at the back cover of the manual or call 2406 5666 for inquiry). Make sure to show product warranty card and receipt during repairing.



## 2. Cleaning and Maintenance

Regular inspection and maintenance could avoid machine failure; user is recommended to check the following on a regular basis:

1. The appliance will still be hot after use. Wait until the appliance cool down before cleaning.
2. To ensure the appliance in good operation, always keep the door surfaces clean. Do not use abrasive cleaners or sharpened metal blade to clean the glass of the oven door as they can scratch the surface, and may cause the glass to break.
  - \* Do not clean the glass by cool cloth during operation to prevent glass crack by cold shrinkage.
3. Shut down the appliance and unplug the power before cleaning.
4. Clean the oven cavity with wet cloth if food or liquid is splashed on the interior surfaces. It is not suggested to use hard material (e.g. metal brush and scouring pad) for cleaning (\*Pic. 1). Use soft and mild detergent if interior surface is too dirty while abrasive detergent is not suggested. Besides, wash the accessories with warm water instead of direct rinsing with cold water (\*Pic. 2).

Reminder: The user can hold the fixing buckle of the upper heater and push the steel strip backward so that the upper heater swings down for cleaning the top of the inner cavity (\*Pic. 3).

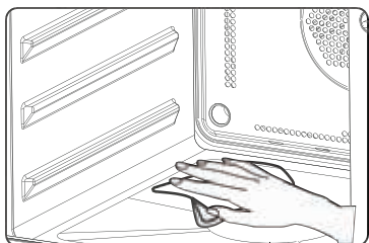

(Pic. 1)

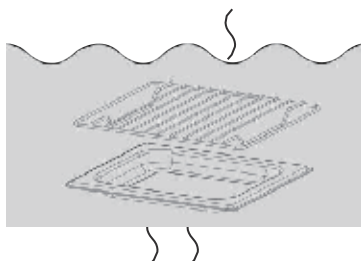

(Pic. 2)

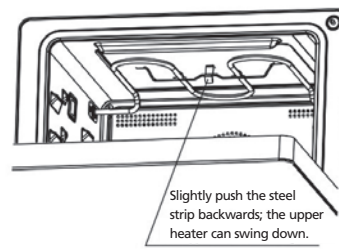

(Pic. 3)

5. It is suggested to use pure water or distilled water to cook. Using tap water for a long time will produce water scale inside the cavity. Do not use mineral water, which speeds up the formation of the scale.
6. Clean the water tank at least once a week. Pull out the tank horizontally and use soft cloth to clean the tank. Put the tank back after cleaning.
7. Clean the rubber sealing of the oven door with soft wet cloth frequently.
8. With electricity disconnected, to avoid wrong operation, use soft cloth to clean the control panel if it gets wet. Make sure do not use abrasive detergent to clean instead.

9. Disconnect the power and clean the oven cavity if the appliance will not be used for a long time. Store it in a ventilating environment without corrosive gas.
10. Repair must be conducted by qualified technicians from Shun Hing Electric Service Centre Limited if the appliance is out of service.
11. Clean the food tray and oil tray with soft material (e.g. cloth) instead of hard material (e.g. metal types) to avoid scratches on trays or damage of protective coating.
12. Never use toxic or corrosive cleaner for cleaning.
13. After cleaning, accessories must be completely dry and install stably before plugging in the power plug.
14. The appliance must be completely cooled and cleaned before storage. Store it in a carton and place it in a dry environment.
15. Never wrap the power cord around the appliance or place any object above the cord, as it may cause damage and rupture the cord.

**CAUTION:** Do not clean the appliance with strong detergent, thinner, gasoline, abrasive powder or metal brush. If there is an odor accumulated inside the oven after a long-time usage, put 5-6 slices of lemon in the cavity and select Steam mode [sss] at 100°C for 15-20 minutes to remove the odor.

**CAUTION:** Do not immerse the appliance in water or splash it with water.

### 3. Product Specification

Model	RSG-TT320/B
Color	Black
Rated Voltage	220-240V ~ 50-60Hz
Rated Power	2,000W
Capacity	32L
Product Dimension (W x D x H) mm	Approx. 472.6 x 517 x 365.7
Cavity Size (W x D x H) mm	Approx. 387 x 342 x 244
Water Tank Capacity (L)	Approx. 0.9
Net Weight (kg)	Approx. 16.7

\* Cavity Size is calculated by measuring the maximum width, depth and height of the cavity. Actual cavity size is less than the above value.

## 4. Product Description

### 4.1 Product Structure

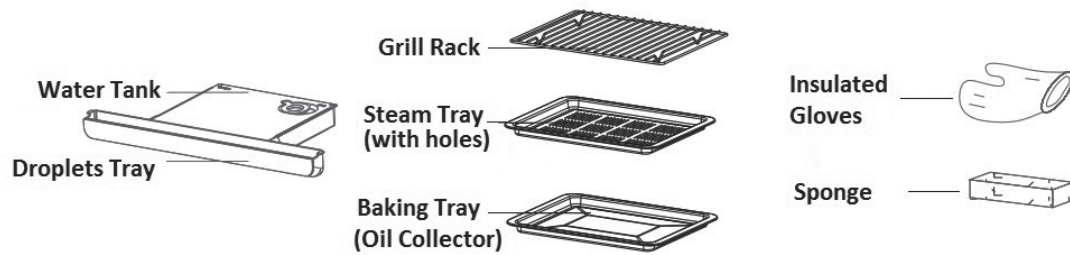
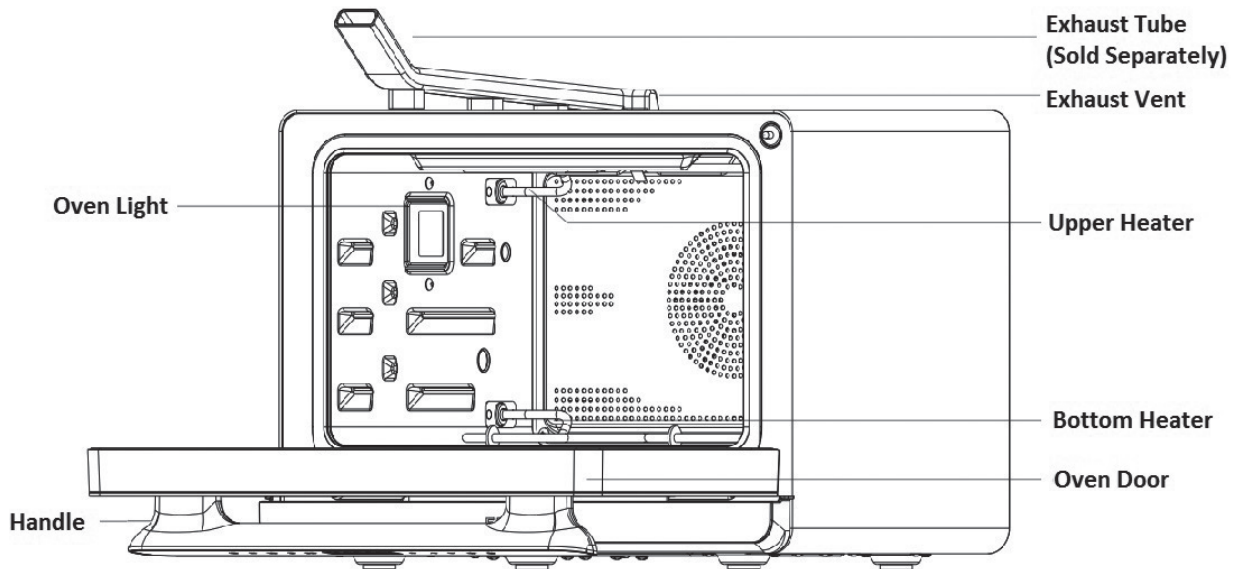

Remarks:

- The above illustration is for reference only. Size may differ from real object and subject to the actual appliance.
- Contact Shun Hing Electric Service Center Limited when the parts of exhaust tube is needed, the contract no. is 2406 5666 for inquiry.

## 4.2 Display and Control Panel Guide



### Control panel guide

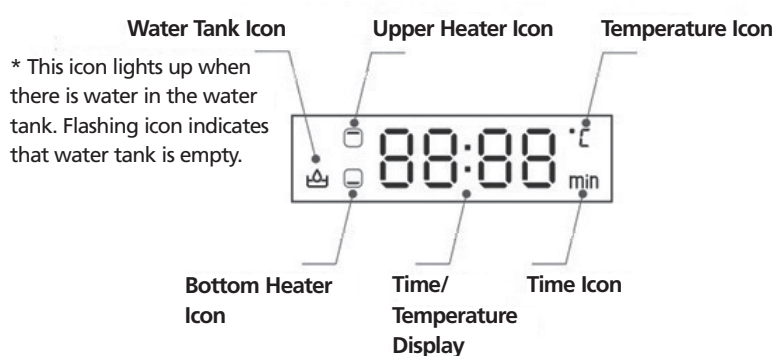

### Display guide



## 5. Operation Instruction

### 5.1 Standby Mode

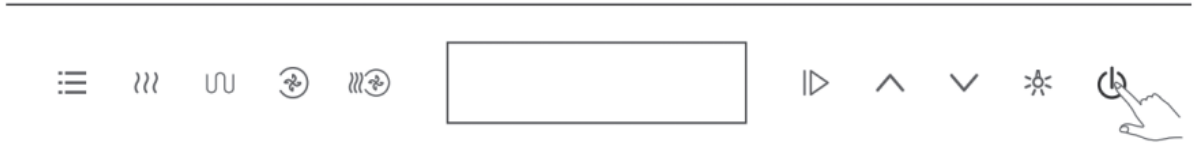

Once the electricity is connected, buzzer will “beep” once and the power button [⏻] lights up. Press the power button [⏻] once, and all the function keys and the time / temperature display 「88:88」 on the display will light up. The appliance enters the standby state, and the user can start the setting.



If the appliance left idle for 1 minute, all function keys and indicator lights on the display will go out, the power button [⏻] will light up, and the product will return to the standby state. The user can press the power button [⏻] once to set again.

### 5.2 Operation description

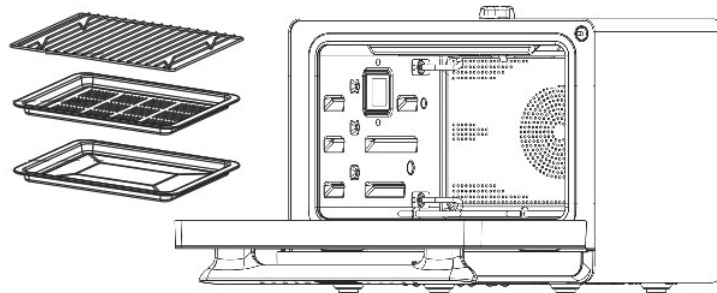

1. Select to use the grill rack, steam tray or baking tray (oil collector) as appropriate for different ingredients;



- If steam function is used (such as Steam and Convection+Steam), fill the water tank with distilled water to prevent the appliance from running out of water;

**ATTENTION!** When cooking with the steam function, if the water in the water tank is insufficient or empty, the water tank icon [  ] and the time indicator on the display panel will flash, and the buzzer will continue to "beep". After filling up the water tank and putting it back into the appliance, press the Enter/Start/Pause button [  ] to continue the operation.

**ATTENTION!** Filling up with excess water will overflow the tank and cause water leakage.









- Close the oven door, connect to the electricity, then the appliance will enter standby mode.
- If need to turn off the product during cooking, press the power button [  ] once, the buzzer will emit a "beep", the cooking operation will stop, all function keys and the indicator lights on the display will go out, and the power button [  ] will light on, the product returns to the power-on state.

### 5.3 Function Description



**Function mode: Steam [  ] / Convection [  ] / Convection + Steam [  ]**



Steps:



- In standby mode, Press Steam [  ], Convection [  ] or Convection +Steam [  ] button;
- Press [  ] or [  ] to set the temperature value (Refer to the function description and cooking timetable.);
- Press [  ] to enter;
- Press [  ] or [  ] to set the time (Refer to the function description and cooking timetable.);
- Press [  ] to start.

**Function mode: Grill [  ] (Upper and Bottom Heaters with Independent Temperature Control)**





The upper and bottom heaters of the product can adjust the temperature independently. When setting the temperature, press [  ] or [  ] until "OFF" shown in Display Panel to turn off the corresponding heater.



Steps:

1. In standby mode, press grill [  ] button;
2. Press [ ^ ] or [ v ] to set the temperature value of the upper heater (  ) (Refer to the function description and cooking timetable.);
3. Press [ |> ] to enter;
4. Press [ ^ ] or [ v ] to set the temperature value of the bottom heater (  ) (Refer to the function description and cooking timetable.);
5. Press [ |> ] to enter;
6. Press [ ^ ] or [ v ] to set the cooking time (Refer to the function description and cooking timetable.);
7. Press [ |> ] to start.

### Function Description and Cooking Timetable

Function	Icon	Preset Temperature	Temperature Adjustable Range	Preset Time	Time Adjustable Range
Steam		100°C	30-100°C	00:20	00:01-03:00
Grill		180°C	100-230°C	00:25	00:01-03:00
Convection		120°C	50-230°C	00:30	00:01-03:00
Convection + Steam		160°C	120-200°C	00:30	00:01-03:00

**ATTENTION!** Preheat 5-10 minutes to make sure the internal temperature is high enough (Or refer to the setting of preheat grill or preheat steam setting in the Auto Menu.)

**ATTENTION!** After every Steam-related operations, suggested to empty the droplets tray to avoid overflow.

**ATTENTION!** During the cooking, the operation is suspended or the oven door is open for a certain of time, the cavity temperature may drop rapidly and below the preheat value to effect the food quality and increase cooking time.

**ATTENTION!** Make sure the ingredients and containers inside can withstand the set temperature. To avoid accident, it is recommended to take out all kind of cling wrap or plastic container beforehand.

**WARNING!** To prevent accident, it is suggested to take out all kind of cling wrap, plastic and paper containers when operating the appliance.



### Reset Cooking Time

If the user need to change the cooking time, press Enter / Pause button [||>] to pause during cooking. Adjust the time with press increase button [^] or decrease button [v], then press Enter / Pause button [||>] to resume operation.

\* When program has completed, oven will keep 10 times and display will show "End".

### 5.4 Auto Menu Operation (Temperature and Time cannot be adjusted)

The user can press the Menu Selection button [≡] to select the built-in menu. Please refer to the table below for details,

\* The codes are classified as A, b, F, S, H, or P. When the user selects the menu, the English code (A, b, F, S, H or P) is selected first, followed by the numeric code (01-24). For the steps, please refer to the instructions below.

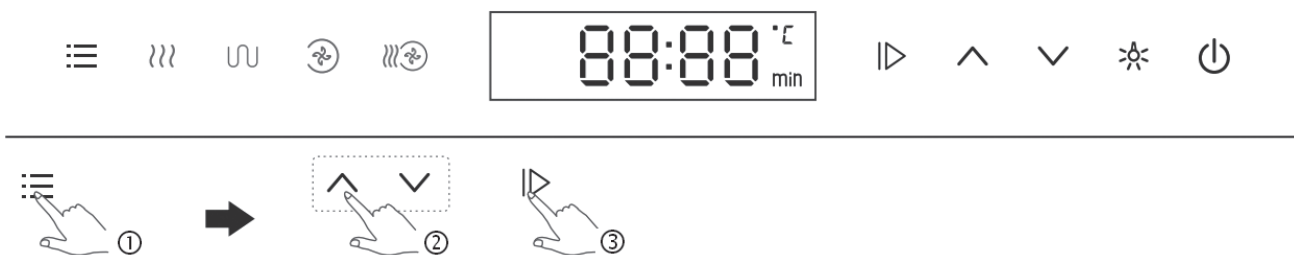

Steps:

1. In standby mode, press Menu Selection button [≡] select built-in menus, Time/Temperature display will show "A01" on the display panel.  
The user can press Menu Selection button [≡] for selecting the menu code (A, b, F, S or H) (Refer to the table of auto menu);
2. Press [^] or [v] to set the menu code (Refer to the table of auto menu);
3. Press [||>] to start.

**Table of Auto Menu**

Code	Cuisine Name	Cooking Mode	Cooking Time (HH: MM)	Temperature
A01	Steamed Yellow Croaker	Steam	0:14	100°C
A02	Steamed Crab	Steam	0:18	100°C
A03	Steamed Pumpkin with Jujube	Steam	0:25	100°C
A04	Steamed Egg	Steam	0:18	100°C
A05	Steamed Scallop with Garlic Vermicelli	Steam	0:15	100°C
A06	Steamed Tilapia	Steam	0:17	100°C
A07	Steamed Bass	Steam	0:15	100°C
A08	Steamed Pork Ribs	Convection +Steam	0:28	120°C
A09	Steamed Dishes Dolls	Steam	0:10	100°C
A10	Steamed Rice	Steam	0:38	100°C
A11	Steam Sweet Potato	Steam	0:26	100°C
A12	Steamed Corn	Steam	0:33	100°C
A13	Steamed Broccoli	Steam	0:25	100°C
A14	Steamed Asparagus	Steam	0:17	100°C
A15	Steamed Carrots	Steam	0:20	100°C
A16	Steamed Vegetables	Steam	0:18	100°C
A17	Reheated Pastry (Steamed Dumplings)	Steam	0:17	100°C
A18	Steamed Chicken	Steam	0:27	100°C

Code	Cuisine Name	Cooking Mode	Cooking Time (HH: MM)	Temperature
A19	Steamed Peanuts	Steam	0:22	100°C
A20	Steamed Lotus Root	Steam	0:22	100°C
A21	Steamed Green Peas	Steam	0:20	100°C
A22	Steamed Green Soy Bean	Steam	0:22	100°C
A23	Steamed Potatoes	Steam	0:28	100°C
A24	Steamed Taro	Steam	0:18	100°C

Code	Cuisine Name	Cooking Mode	Cooking Time (HH: MM)	Temperature
b01	Fish With Lemon	Convection	0:25	200°C
b02	Steamed Abalone	Convection + Steam	0:21	180°C
b03	Grilled Sea Bass	Convection	0:45	200°C
b04	Grilled Beef Steak	Convection + Steam	0:19	190°C
b05	Baked Corn	Grill	0:26	200°C
b06	Maotai-Flavor Ribs	Convection + Steam	0:33	200°C

Code	Cuisine Name	Cooking Mode	Cooking Time (HH: MM)	Temperature
F01	Pear sweet soup with Chuan Pei	Steam	1:02	100°C
F02	Orange Sugar Water	Steam	0:50	100°C
F03	Braised Papaya in Milk	Steam	0:26	100°C
F04	Stewed Sweet Pear with White Fungus	Steam	0:58	100°C
F05	Chinese Date, Chinese Wolfberry and Tremella Soup	Convection + Steam	0:43	110°C
F06	Braised Tremella with Lotus Seed and Lily	Convection + Steam	1:18	110°C
F07	Soup Of Coix Seed, Lotus Seed and Tremella	Convection + Steam	0:40	110°C
F08	Stewed Sweet Pear with White Fungus	Steam	0:33	100°C
F09	Peach Gum Snow Swallow Tremella Soup	Steam	1:00	100°C
F10	Stewed Pear with Papaya	Steam	0:58	100°C

Code	Cuisine Name	Cooking Mode	Cooking Time (HH: MM)	Temperature
S01	Keep Warm (Fish)	Steam	0:30	35°C
S02	Keep Warm (Meat)	Convection	0:30	50°C
S03	Keep Warm (Vegetable)	Steam	0:30	40°C
S04	Keep Warm (Cooked W/heaten Food)	Steam	0:45	35°C
S05	Keep Warm (Soup)	Steam	1:00	50°C

Code	Cuisine Name	Cooking Mode	Cooking Time (HH: MM)	Temperature
H01	Bread	Ferment	0:25	35°C
		Secondary Fermentation	1:40	40°C
		Convection	0:15	50°C
		Grill	0:15	180°C
H02	Yogurt	Ferment	9:00	40°C
H03	Reheat Bread	Convection + Steam	0:08	180°C
H04	Dried Apple	Convection	1:30	110°C
H05	Lemon Dryslice	Convection	1:45	110°C
H06	Warm Wine	Steam	0:08	80°C
H07	Warm Milk	Grill	0:05	180°C
H08	Hot Chocolate	Grill	0:14	180°C

## 5.5 Grill Preheat/Steam Preheat Setting



### Steps:

- In standby mode, press Menu Selection button [≡] select built-in menus, Time/Temperature display will show "A01" on the display panel.  
The user can press Menu Selection button [≡] to select the code to P (Refer to the table of auto menu);  
Press [^] or [v] to set the menu code (Refer to the table of auto menu);
- Press [||] to confirm;
- Press [^] or [v] to set the temperature (Refer to the table of auto menu);
- Press [||] to start.

Table of Auto Menu

Code	Cuisine Name	Cooking Mode	Cooking Time	Temperature
P01	Preheat (Grill)	N/A	Cannot be adjusted	Preset 180°C Adjust range 100-230°C
P02	Preheat (Steam)	N/A	Cannot be adjusted	Preset 100°C Adjust range 50-100°C

## 5.6 Defrost / Fermentation Setting

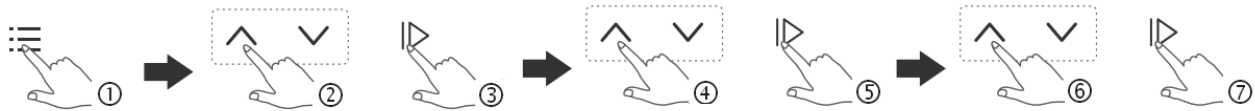

Steps:

1. In standby mode, press Menu Selection button [ ≡ ] select built-in menus, Time/Temperature display will show "A01" on the display panel.  
The user can press Menu Selection button [ ≡ ] to select the code to P (Refer to the table of auto menu);
2. Press [ ^ ] or [ v ] to set the menu code (Refer to the table below for menu code and details);
3. Press [ |> ] to enter;
4. Press [ ^ ] or [ v ] to set the temperature (Refer to the table of auto menu.);
5. Press [ |> ] to enter;
6. Press [ ^ ] or [ v ] to set the time (Refer to the table of auto menu.);
7. Press [ |> ] to start.

**Table of Auto Menu**

Code	Cuisine Name	Cooking Mode	Cooking Time	Temperature
P03	Defrost	N/A	Preset 0:20 <b>Adjust range 0:01-3:00</b>	Preset 50°C <b>Adjust range 40-60°C</b>
P04	Fermentation	N/A	Preset 1:00 <b>Adjust range 0:01-12:00</b>	Preset 40°C <b>Adjust range 30-40°C</b>

### 5.7 Additional Functions (Temperature and Time cannot be adjusted)

In addition to each cooking modes, additional functions are also available in the Auto Menu [ ≡ ] for the user to choose (The code and details can refer to the following table).

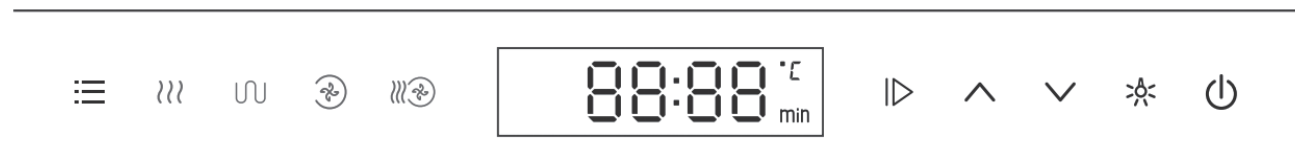

Steps:

1. In standby mode, press Menu Selection button [ ≡ ] select built-in menus, Time/Temperature display will show "A01" on the display panel.  
The user can press Menu Selection button [ ≡ ] to select the code to P (Refer to the table of auto menu);
2. Press [ ^ ] or [ v ] to set the menu code (Refer to the table of auto menu);
3. Press [ |> ] to start.

**Table of Auto Menu**

Code	Cuisine Name	Cooking Mode	Cooking Time (HH: MM)	Temperature
P05	Warm Towel	Steam	0:06	50°C
P06	Warm Cup	Steam	0:05	50°C
P07	Pipeline Cleaning	Steam	0:06	90°C
P08	Sterilization	Convection +Steam	0:20	110°C
P09	Descaling	Steam	0:25	100°C
P10	Cavity Dry	Convection	0:13	200°C

## 5.8 Setting of Descaling function

Firstly, user can add 20ml of moderate detergent and 200ml of water into the water tank, then select the code (P09) descaling function in the auto menu, and then press [▶] to start the operation.

**ATTENTION!** The descaling function is finished, remove and empty the water tank, and then put back to the appliance. Wipe the oven cavity to dry.

## 5.9 Real-time Temperature

During cooking process, the user can press and hold the Menu Section button [☰] for 3 seconds to query the real-time temperature.



### Cooking Tips:

1. The cooking time of different food is varied by temperature, types, shade and quantity etc. The above cooking time is for reference only, user may adjust the cooking time according to the actual cooking condition and experiences.
2. Frosted food may take longer time to cook. User may adjust the cooking time according to the actual cooking condition.
3. To avoid affecting the cooking performance or burnt, always pay attention to the food when grilling to avoid food burns.
4. When grilling, steam may appear on the glass of the oven door due to water evaporated from the food. It is normal phenomenon and does not affect the operation.
5. Never rub the glass with cool water during operation or just after use, otherwise the glass may crack.
6. To avoid overheat, the heating elements are equipped with an auto power switching device. Heating elements will turn off temporarily when the oven reaches the set temperature, and resume in operation when the oven cools down.
7. Do not take out the food when heating; otherwise the food may not be heated up adequately.
8. For accurate cooking time control and avoid influencing cooking effect, place food inside appliance after preheat is completed.

## 5.10 Child Lock Function



Product is equipped with child lock so that children cannot switch on or change any setting accidentally.



- i. **Activating the Child Lock:** Press and hold the "Child Lock" button for 3 seconds. Child lock is enabled. The "Child Lock" icon lights up (as shown in the diagram below).
- ii. **Cancelling the Child Lock:** Press and hold the "Child Lock" button for 3 seconds to disable the child lock function. The "Child Lock" icon goes off.

### 5.11 Application of oven light

The built-in oven lamp will turn on under the following situations:

- i. When the product entering standby mode, open the oven door under any circumstances, it will light on for approx. 1 minute;
- ii. After starting an operation, it will light on for approx. 3 minutes;
- iii. Open the oven door after a cooking operation finished, it will light on for approx. 2 minutes.
- iv. Press Oven Light button [  ] during operation, it will light on, and press [  ] once again to turn off;

## 6. Troubleshooting

Error Code/Phenomenon	Possible Cause	Solution
Er3	Open circuit of the bottom tube sensor in cavity	Contact Shun Hing Electric Service Centre Limited to check and repair
Er4	Short circuit of the bottom tube sensor in cavity	
Er5	Open circuit of the evaporation plate sensor	
Er6	Short circuit of the evaporation plate sensor	
Er7	Open circuit of the upper tube sensor in cavity	
Er8	Short circuit of the upper tube sensor in cavity	
Black screen	<ol style="list-style-type: none"> <li>1. The appliance is not connected to the power supply</li> <li>2. The power cord does not function properly</li> </ol>	<ol style="list-style-type: none"> <li>1. Connect the appliance to the power supply</li> <li>2. Contact Shun Hing Electric Service Centre Limited to check and repair</li> </ol>
Abnormal indication on the display screen	<ol style="list-style-type: none"> <li>1. The display screen is damaged</li> <li>2. Certain component of the PCB is damaged</li> </ol>	Contact Shun Hing Electric Service Centre Limited to check and repair
Water or steam leakage through the oven door during cooking	<ol style="list-style-type: none"> <li>1. The oven door is not closed tightly</li> <li>2. The door seal is damaged</li> </ol>	<ol style="list-style-type: none"> <li>1. Close the door properly</li> <li>2. Contact Shun Hing Electric Service Centre Limited to check and repair</li> </ol>
The oven light does not work	<ol style="list-style-type: none"> <li>1. The oven light is damaged</li> <li>2. Main PCB malfunction</li> </ol>	Contact Shun Hing Electric Service Centre Limited to check and repair
Fan motor malfunction	<ol style="list-style-type: none"> <li>1. The fan motor is damaged</li> <li>2. Main PCB malfunction</li> </ol>	
Button failure	<ol style="list-style-type: none"> <li>1. Improperly assembled or damaged panel</li> <li>2. Certain component of the PCB is damaged</li> </ol>	
No steam generated	<ol style="list-style-type: none"> <li>1. The hose is folded, blocked or damaged</li> <li>2. The water pump is damaged</li> <li>3. The waterflood system is improperly sealed</li> </ol>	

---

Note:

1. Check the following if the appliance does not function properly:
  - Whether the power cord is plugged in;
  - Whether the oven door is closed tightly;
  - Whether the water tank is installed correctly;
  - Whether the MCB is tripped or a fuse has blown out;
  - Whether the child safety lock is activated.
2. When the appliance is accidentally turned on without any food in the cavity: press the Power button [⏻] immediately to stop it from operating.

Tips.

- After the cooking is finished, it is normal for the exhaust fan to continue working for about 2 minutes after operation, which dissipates heat from the cavity;
- The appliance will stop operating automatically when the door is opened during the cooking process;
- After closing the oven door, the appliance will resume operation automatically.

## 7. Special Avowal

1. The content in the manual has been checked. Our company reserves the hermeneutic power to any printing errors or misunderstanding on the content.
2. If there are technical improvements on the appliance, the operation manual will be updated in new version without prior notice. The product appearance and specification are subject to the manufacturer information.
3. In case there is any inconsistency or conflict between the English versions and Chinese versions of the terms, the Chinese versions shall prevail.
4. E-copy of user manual can be sent by e-mail on request, please call Shun Hing Electric Works of Engineering Co., Ltd. at 2861 2767.

## 8. After Sales Service

1. For any defect, in the judgement of technician from Shun Hing Electric Service Center Limited, caused under normal use, our company is responsible for repairing any parts of the said electrical appliance free of charge within one year guarantee period commencing from the date of purchase. Any defect part which has been replaced shall become our property. Warranty service does not cover the repair or replacement of spare part consumable parts such as power cord, water tank, oven door, enclosure, baking tray, grill rack, steam tray, droplets tray and insulating glove, etc. If appliance is used improperly, for commercial use or semi-commercial use, or not following the instructions in the operation manual, the warranty becomes invalid and our company will refuse any liability and repairing cost for the damage caused.
2. User must present the official invoice/redemption voucher and the warranty registration card with the chop from sales point/redemption center for maintenance. For enquiries, please call Shun Hing Electric Service Center Limited hotline at 2406 5666.



# 備忘録 MEMO

---

## 信興電工工程有限公司

**SHUN HING ELECTRIC WORKS AND ENGINEERING CO., LTD.**

辦公室：香港九龍尖沙咀東部麼地道67號半島中心9樓

電話：2861 2767

圖文傳真：2865 6706

網址：<http://www.rasonic.com>

電郵：[shew@shunhinggroup.com](mailto:shew@shunhinggroup.com)

Office: 9/F., Peninsula Centre, 67 Mody Road, Tsimshatsui East, Kowloon, H.K.

Tel: 2861 2767

Fax: 2865 6706

Website: <http://www.rasonic.com>

E-mail: [shew@shunhinggroup.com](mailto:shew@shunhinggroup.com)

保養及維修 Maintenance and Repair Service:

## 信興電器服務中心有限公司

**SHUN HING ELECTRIC SERVICE CENTRE LTD.**

香港新界葵涌勝耀街2號信興中心11樓

服務熱線：2406 5666

傳真號碼：2408 0316

網址：<http://www.shesc.com/zh>

11/F, Shun Hing Centre, 2 Shing Yiu Street, Kwai Chung, N.T. HK

Service Hotline: 2406 5666

Fax No.: 2408 0316

Website: <http://www.shesc.com/en>

客戶服務中心：

香港新界葵涌勝耀街2號信興中心1樓

九龍尖沙咀東部麼地道67號半島中心B座9樓

香港天后琉璃街7號柏景中心22樓

澳門慕拉士大馬路193-199號南嶺工業大廈5樓I座

Customer Service Centre

1/F, Shun Hing Centre, 2 Shing Yiu Street, Kwai Chung, N.T.

9/F., Block B, Peninsula Centre, 67 Mody Road, Tsim Sha Tsui East, Kowloon

22/F, Parkview Centre, 7 Lau Li Street, Tin Hau, Hong Kong

Avenida de Venceslau de Morais, No. 193-199,5 andar - I, Edf. Industrial Nam Leng, Macau

有關最新之香港及澳門客戶服務中心資料，請參閱信興服務中心網址：<http://www.shesc.com/zh>

For the latest information of Hong Kong and Macau service center, please visit <http://www.shesc.com/en>